

Linear

TANA SP R014

Fixture Guide

KKDÖ

Indoor | Surface | Output up to 712lm/m (217lm/ft)



Key applications

- ✓ Architectural detail
- ✓ Cabinet & furniture
- ✓ Direct lighting
- ✓ Display case
- ✓ Interior
- ✓ Retail display
- ✓ Shelving display

Key features

- ✓ Custom lengths
- ✓ Constant Voltage (CV)
- ✓ Diffusion: homogenous
- ✓ Direct view
- ✓ Extensive CCT range
- ✓ IP40 dry area

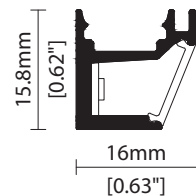

MOUNTING METHODS



KKCP-10 Concealed clip

Linear

TANA SP R014

Specification sheet



Dimensions	H15.8/W16/L103-2020mm (H0.62/W0.63/L4.06-79.53in)
PCB Cut-point	41.7mm increment/2000mm max (1.64in increment/78.74in max)
LED Pitch	6.95mm-144LED/m (0.27in - 44LED/ft)
Chip	s-line k-line
Cover/Optics	Diffused (60°)
CCT	s-line: 1900K/2100K/2300K/2500K/2700K/3000K/3500K/4000K/5000K, Single colours: Red/Green/Blue/Orange/Amber k-line: 1900K/2100K/2300K/2500K/2700K/3000K/3500K/4000K/5000K
LED binning	s-line: 2-step MacAdam ellipse k-line: 3-step MacAdam ellipse
CRI	≥ 92
Lifetime	50,000 hours @ 25°C (50,000 hours @ 77°F)
Operating temp	T _a = -25 to 50°C (T _c max = 68°C) T _a = -13 to 122°F (T _c max = 154°F)
IP Rating	IP40
Finish	Silver anodised
Mounting	Surface mounting via concealed clips
Power feed	Hardwire tails
Control	0-10V/1-10V/DMX/DALI



LED Grading Key

Exclusive Grade

s s-line*	*KKDC tuned CCT range
2-step CCT range	

Base Grade

k k-line	3-step commercial range Energy Star CCTs
-----------------	--

Power consumption	Supply voltage	Supply current
14W/m (4.27W/ft)	24V DC	0.58A/m (0.18A/ft)

Performance Data (3000K)

	R1	R2	R3	R4	R5	R6	R7	R8	R9	R10	R11	R12	R13	R14
k-line	93	97	98	91	92	94	92	83	64	91	91	75	94	98

	Diffused Cover	CRI	R9	Rf	Rg
s-line	712lm/m (217lm/ft) 51lm/W	93	65	-	-
k-line	672lm/m (205lm/ft) 48lm/W	92	64	-	-

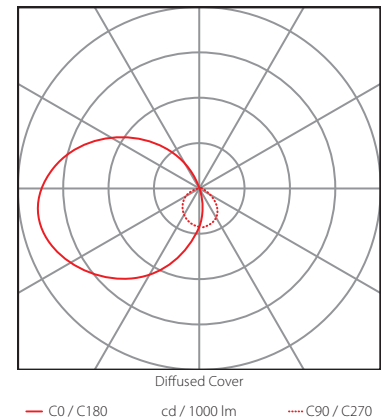
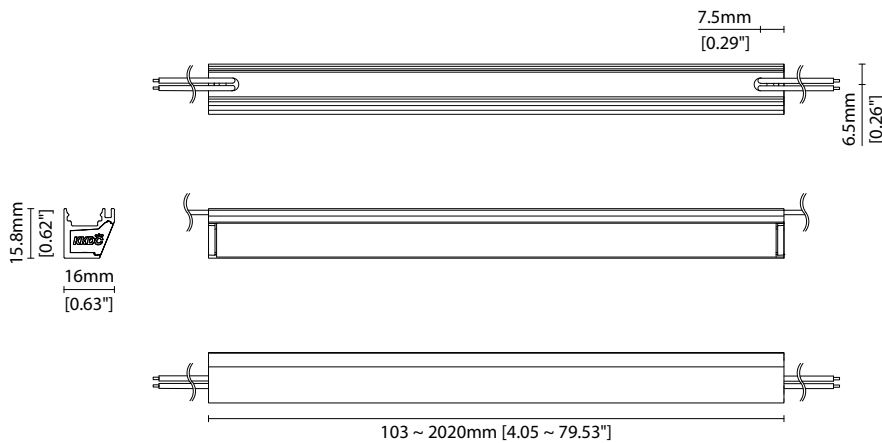

Data derived from independent UKAS / IESNA LM-79-08 accredited testing of production samples.

TANA SP R014

Code Table



FIXTURE

Model	Finish	Cover	Grade ¹	LED	Colour (CCT)	Length Availability ²	IP	Cable Length	Power Feed ³	Input		
TANA SP	TS Silver Anodised	SA	Diffused C	s	R014	R014	m	1000mm/ 39.37"	1000	Single no sheath tail	DC 24V g	
					1900K	19	61.7-2020mm 41.7mm increments					
					2100K	21	i					
					2300K	23						
					2500K	25						
					2700K	27						
					3000K	30						
					3500K	35						
					4000K	40						
					5000K	50						
					RED	RED						s-only
					GREEN	GRN						
					BLUE	BLU						
ORANGE	ORN											
AMBER	AMB											

¹ Refer to **Cover/Lens options** on **Options** page

² Refer to **LED Grading Key** on **Specification sheet** page

³ Refer to **Length Availability List** or enter total run length instead of length code

⁴ Refer to **Power Feed Options** on **Options** pages

Code Example:

TS	-	SA	-	C	-	s	-	R014	-	35	-	m	-	520	-	40	-	1000	-	D00X	-	g
TANA SP		Silver Anodised		Diffused				R014		3500K		520mm		IP40		1000mm/39.37"		Double no sheath tail		DC 24V		

ACCESSORIES

Mounting Accessories

TMEC-02	End cap bracket pair
TMEC-01	End cap pair

* Refer to **Mounting accessories** on **Accessories** pages

Connection Accessories

KKCN-02	2 PIN male & female JST 50mm (1.97in) pair
KKCN-04	2 PIN male & female JST 300mm (11.81in) pair
KKCN-05	2 PIN JST 300mm (11.81in) extension lead

* Refer to **Power feed** on **Accessories** pages

PSU/Driver

0-10V/1-10V/DALI/DMX

* Refer to **Driver/PSU Options** page for details or provide requirement and KKDC to offer the suitable option

Linear

TANA SP R014

Length Availability List



Length Code		Fixture Length ¹		LED Strip ²		End Cap Dimension ³		Wattage (W)	Output (lm)
Metric	Imperial(US)	Metric	Imperial(US)	Metric	Imperial(US)	Metric	Imperial(US)		3000K (Test Data)
m0103	i0004	103mm	4.07in	83mm	3.28in	0mm	0.00in	1.17	56
m0145	i0006	145mm	5.71in	125mm	4.92in	0mm	0.00in	1.75	84
m0187	i0007	187mm	7.35in	167mm	6.56in	0mm	0.00in	2.33	112
m0228	i0009	228mm	8.99in	208mm	8.20in	0mm	0.00in	2.92	140
m0270	i0011	270mm	10.63in	250mm	9.84in	0mm	0.00in	3.50	168
m0312	i0012	312mm	12.27in	292mm	11.48in	0mm	0.00in	4.08	196
m0353	i0014	353mm	13.91in	333mm	13.12in	0mm	0.00in	4.67	224
m0395	i0016	395mm	15.55in	375mm	14.76in	0mm	0.00in	5.25	252
m0437	i0017	437mm	17.19in	417mm	16.40in	0mm	0.00in	5.83	280
m0478	i0019	478mm	18.83in	458mm	18.04in	0mm	0.00in	6.42	308
m0520	i0020	520mm	20.47in	500mm	19.69in	0mm	0.00in	7.00	336
m0562	i0022	562mm	22.11in	542mm	21.33in	0mm	0.00in	7.58	364
m0603	i0024	603mm	23.75in	583mm	22.97in	0mm	0.00in	8.17	392
m0645	i0025	645mm	25.39in	625mm	24.61in	0mm	0.00in	8.75	420
m0687	i0027	687mm	27.03in	667mm	26.25in	0mm	0.00in	9.33	448
m0728	i0029	728mm	28.67in	708mm	27.89in	0mm	0.00in	9.92	476
m0770	i0030	770mm	30.31in	750mm	29.53in	0mm	0.00in	10.50	504
m0812	i0032	812mm	31.96in	792mm	31.17in	0mm	0.00in	11.08	532
m0853	i0034	853mm	33.60in	833mm	32.81in	0mm	0.00in	11.67	560
m0895	i0035	895mm	35.24in	875mm	34.45in	0mm	0.00in	12.25	588
m0937	i0037	937mm	36.88in	917mm	36.09in	0mm	0.00in	12.83	616
m0978	i0039	978mm	38.52in	958mm	37.73in	0mm	0.00in	13.42	644
m1020	i0040	1020mm	40.16in	1000mm	39.37in	0mm	0.00in	14.00	672
m1062	i0042	1062mm	41.80in	1042mm	41.01in	0mm	0.00in	14.58	700
m1103	i0043	1103mm	43.44in	1083mm	42.65in	0mm	0.00in	15.17	728
m1145	i0045	1145mm	45.08in	1125mm	44.29in	0mm	0.00in	15.75	756
m1187	i0047	1187mm	46.72in	1167mm	45.93in	0mm	0.00in	16.33	784
m1228	i0048	1228mm	48.36in	1208mm	47.57in	0mm	0.00in	16.92	812
m1270	i0050	1270mm	50.00in	1250mm	49.21in	0mm	0.00in	17.50	840
m1312	i0052	1312mm	51.64in	1292mm	50.85in	0mm	0.00in	18.08	868
m1353	i0053	1353mm	53.28in	1333mm	52.49in	0mm	0.00in	18.67	896
m1395	i0055	1395mm	54.92in	1375mm	54.13in	0mm	0.00in	19.25	924
m1437	i0057	1437mm	56.56in	1417mm	55.77in	0mm	0.00in	19.83	952
m1478	i0058	1478mm	58.20in	1458mm	57.41in	0mm	0.00in	20.42	980
m1520	i0060	1520mm	59.84in	1500mm	59.06in	0mm	0.00in	21.00	1008
m1562	i0061	1562mm	61.48in	1542mm	60.70in	0mm	0.00in	21.58	1036
m1603	i0063	1603mm	63.12in	1583mm	62.34in	0mm	0.00in	22.17	1064
m1645	i0065	1645mm	64.76in	1625mm	63.98in	0mm	0.00in	22.75	1092
m1687	i0066	1687mm	66.40in	1667mm	65.62in	0mm	0.00in	23.33	1120
m1728	i0068	1728mm	68.04in	1708mm	67.26in	0mm	0.00in	23.92	1148
m1770	i0070	1770mm	69.69in	1750mm	68.90in	0mm	0.00in	24.50	1176
m1812	i0071	1812mm	71.33in	1792mm	70.54in	0mm	0.00in	25.08	1204
m1853	i0073	1853mm	72.97in	1833mm	72.18in	0mm	0.00in	25.67	1232

TANA SP R014

Length Availability List



Length Code		Fixture Length ¹		LED Strip ²		End Cap Dimension ³		Wattage (W)	Output (lm)
Metric	Imperial(US)	Metric	Imperial(US)	Metric	Imperial(US)	Metric	Imperial(US)		3000K (Test Data)
m1895	i0075	1895mm	74.61in	1875mm	73.82in	0mm	0.00in	26.25	1260
m1937	i0076	1937mm	76.25in	1917mm	75.46in	0mm	0.00in	26.83	1288
m1978	i0078	1978mm	77.89in	1958mm	77.10in	0mm	0.00in	27.42	1316
m2020	i0080	2020mm	79.53in	2000mm	78.74in	0mm	0.00in	28.00	1344

¹ Actual total overall length of light fixture (LED strip + end caps + void/wire hole)

² Actual length of PCB strip

³ Actual length of 2x end caps

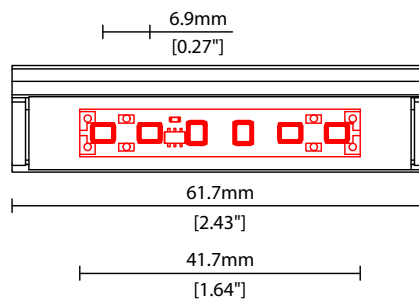

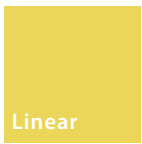

TANA SP R014

Options



COVER/LENS OPTIONS

* Options are an integral part of the fixture ordering codes. Please refer to **Code Table** pages.

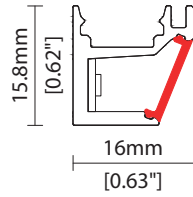

C Diffused cover
W16/H15.8mm (W0.63/H0.62")

POWER FEED OPTIONS

* Options are an integral part of the fixture ordering codes. Please refer to **Code Table** pages.

1000 S00X 1000mm (39.37") Single no sheath tail

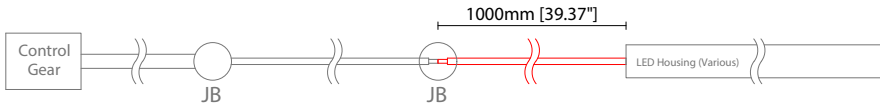

1000 D00X 1000mm (39.37") Double no sheath tail

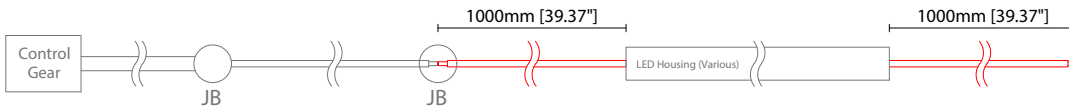

3000 S00X 3000mm (118.11") Single no sheath tail

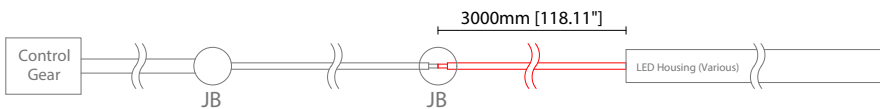

3000 D00X 3000mm (118.11") Double no sheath tail

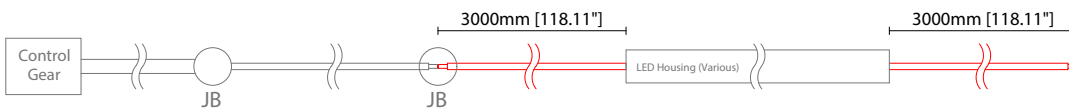

Key

Control Gear Power supply, sub-controllers & control systems
 JB Junction box / cable connection

Linear

TANA SP R014 Accessories

KKDC

MOUNTING ACCESSORIES

Note: Accessories are to be ordered separately with corresponding code shown below.

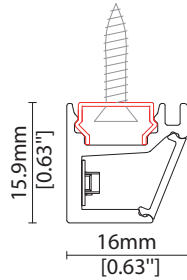

KKCP-10

Concealed clip
(Allow 2 per metre/40in)
S/Steel finish
L20/W16/H16mm
(L0.79/W0.63/H0.63")

POWER FEED

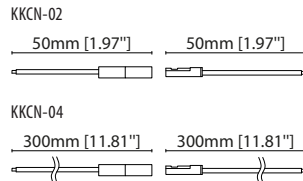

KKCN-02 50mm (1.97in) pair

KKCN-04 300mm (11.81in) pair

2 PIN male + female JST connector set

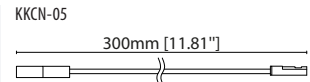

KKCN-05

2 PIN 300mm (11.81in) extension lead (JST)

KKDC CONTROL



IP20
Plastic housing
L170/W59/H29mm
(L6.69/W2.32/H1.14in)

KKDM-06 1-10V

visDIM dimmable sub-controller
(4 x 8A max @ 12-36V)



IP20
Plastic housing
L170/W53.4/H28mm
(L6.69/W2.10/H1.10in)

KKSC-05 DMX

visDIM dimmable sub-controller
(4 x 5A max @ 12-36V)

Linear

TANA SP R014

Accessories

KKDÖ

KKDC CONTROL (CONTINUED)



IP20
Plastic housing
L170/W59/H29mm
(L6.69/W2.32/H1.14in)

KKDL-02 DALI

visDIM dimmable sub-controller
(4 x 8A max @ 12-36V)



IP20
Plastic housing
L166/W53.4/H23mm
(L6.54/W2.10/H0.91in)

KKDL-03 DALI

visDIM dimmable sub-controller
(4 x 5A max @ 12-36V)

AVAILABLE PSU OPTIONS

Control Mode	PSU (Order Code)	Input Voltage AC	Output Voltage DC	Rated Output Current	Rated Power	Dim %	IP Rating
Switched	CEN-60-24	90-295V	24V	2.5A	60W	-	IP67
	HLG-60H-24	90-305V	24V	2.5A	60W	-	IP67
	HLG-100H-24	90-305V	24V	4.0A	100W	-	IP67
	HLG-150H-24	90-305V	24V	6.3A	150W	-	IP67
	HLG-240H-24	90-305V	24V	10A	240W	-	IP67
0-10V (1-10V)	PWM-40-24	90-305V	24V	1.67A	40W	100-0.15 (100-10)	IP67
	PWM-60-24	90-305V	24V	2.5A	60W	100-0.15 (100-10)	IP67
	PWM-90-24	90-305V	24V	3.67A	90W	100-0.15 (100-10)	IP67
	PWM-120-24	90-305V	24V	5.0A	120W	100-0.15 (100-10)	IP67
DALI	LIN100A1	120-277V	24V	1A per channel	100W	100-0.1	IP66/IP40
DMX RGB	LIN100A1	120-277V	24V	1.33A per channel	100W	100-0.1	IP66/IP40
DMX RGBW	LIN100A1	120-277A	24V	1A per channel	100W	100-0.1	IP66/IP40

Flicker Free Options - Combination of PSU+ sub-controller

Control Mode	PSU (Order Code)	Sub-controller (Order Code)	Input Voltage AC	Output Voltage DC	Rated Output Current	Rated Power	Dim %	IP Rating PSU/ Sub-controller
0-10V or 1-10V	CEN-60-24	KKDM-06	90-295V	24V	2.5A	60W	100-0.9	IP67/IP20
	HLG-60H-24	KKDM-06	90-295V	24V	2.5A	60W	100-0.9	IP67/IP20
	HLG-100H-24	KKDM-06	90-295V	24V	4.0A	100W	100-0.9	IP67/IP20
	HLG-150H-24	KKDM-06	90-295V	24V	6.3A	150W	100-0.9	IP67/IP20
	HLG-240H-24	KKDM-06	90-295V	24V	10.0A	240W	100-0.9	IP67/IP20
DALI	CEN-60-24	KKDL-02/03	90-295V	24V	2.5A	60W	100-0.1	IP67/IP20
	HLG-60H-24	KKDL-02/03	90-305V	24V	2.5A	60W	100-0.1	IP67/IP20
	HLG-100H-24	KKDL-02/03	90-305V	24V	4.0A	100W	100-0.1	IP67/IP20
	HLG-150H-24	KKDL-02/03	90-305V	24V	6.3A	150W	100-0.1	IP67/IP20
	HLG-240H-24	KKDL-02/03	90-305V	24V	10.0A	240W	100-0.1	IP67/IP20
DMX RGB	CEN-60-24	KKSC-05	90-295V	24V	2.5A	60W	100-0.9	IP67/IP20
	HLG-60H-24	KKSC-05	90-305V	24V	2.5A	60W	100-0.9	IP67/IP20
	HLG-100H-24	KKSC-05	90-305V	24V	4A	100W	100-0.9	IP67/IP20
	HLG-150H-24	KKSC-05	90-305V	24V	6.3A	150W	100-0.9	IP67/IP20
	HLG-240H-24	KKSC-05	90-305V	24V	10.0A	240W	100-0.9	IP67/IP20

¹ The items shown above cover the most frequently used specification but does not exhaust the possible options

² PSU and/or driver can be chosen from the table, or KKDC may recommend the best option upon receipt of the controls requirement and installation environment

³ Electrical shop drawing will include detailed information of PSU and relevant control drivers

⁴ Cut sheets are available on the controls section of www.kkdc.lighting or upon request